



LLDP Protocol

Teldat Dm813-I

Copyright© Version 11.05 Teldat SA

Legal Notice

Warranty

This publication is subject to change.

Teldat offers no warranty whatsoever for information contained in this manual.

Teldat is not liable for any direct, indirect, collateral, consequential or any other damage connected to the delivery, supply or use of this manual.

Table of Contents

Chapter 1	LLDP	1
1.1	Introduction	1
1.2	Frame format	1
Chapter 2	Configuration	7
2.1	Accessing the configuration	7
2.2	LLDP Configuration Commands	7
2.2.1	LLDP ENABLE	7
2.2.2	LLDP TIMER.	7
2.2.3	LLDP TLV-SELECT.	8
2.2.4	LLDP VOICE.	8
Chapter 3	Configuration Example	10
3.1	Configuring LLDP.	10

Chapter 1 LLDP

1.1 Introduction

The Link Layer Discovery Protocol (LLDP) allows for device characteristics to be advertised in a network. This means that other devices connected to that same network can learn about the broadcasting device (addresses, ports, vlan, etc.) by listening to packets from this protocol.

A device where LLDP is enabled, periodically sends information on the system over its interfaces. Additionally, it allows IP telephones to configure parameters for other devices connected to the network. By listening to messages sent by the protocol, said devices obtain their configuration.



Note

Currently, LLDP can only be enabled in Ethernet interfaces and subinterfaces.

1.2 Frame format

LLDP protocol frames travel in Ethernet frames with the following format:

Preamble	Dst MAC	Src MAC	Ethertype	LLDPDU	Frame Check Sequence
	01:80:c2:00:00:0e 01:80:c2:00:00:03 01:80:c2:00:00:00	Station Address	0x88CC		

Fig. 1: Ethernet frame with LLDP

Where destination MAC is a multicast MAC address. The *Ethertype* category corresponds to the LLDP protocol, whose value is 0x88CC.

LLDPDU contains information on the LLDP. This is a sequence of type-length-value (TLV) structures. A TLV takes the following format:

Type	Length	Value
7 bits	9 bits	0-510 octets

Fig. 2: TLV structure

An LLDPDU is made up of TLVs. Out of these, four are basic mandatory ones and the rest are optional. Its structure is as follows:

Chassis ID TLV	Port ID TLV	Time to Live TLV	Optional TLVs	End of LLDPDU TLV
Type = 1	Type = 2	Type = 3	Zero or more complete TLVs	Type = 0, Length = 0

Fig. 3: LLDPDU

Basic TLVs, which must always go in an LLDPDU, are as follows:

- **Chassis ID:** Mandatory TLV identifying the LAN from which the LLDPDU is sent. Since there are different ways of identifying this, a subtype in the TLV information field can be set. TLV *chassis ID* format is as follows:

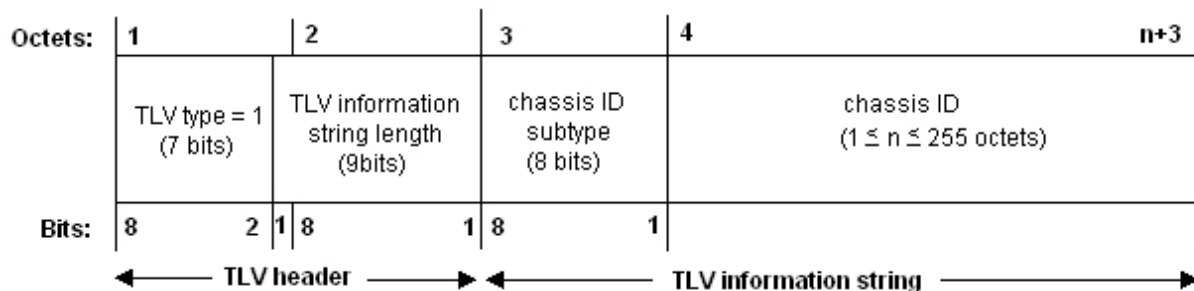

Fig. 4: TLV Chassis ID format

This TLV has a subtype field, which identifies the type of information contained in the *chassis ID* field. Possible values for said subtype field are as follows:

Chassis ID Subtypes

ID subtype	ID basis
0	Reserved.
1	Chassis component (IETF RFC 4133).
2	Interface alias (IETF RFC 2863).
3	Port component (IETF RFC 4133).
4	MAC address (IEEE Std 802).
5	Network address.
6	Interface name (IETF RFC 2863).
7	Locally assigned.
8-255	Reserved.

Since the MAC interface is sent from the same place as the packet, the *chassis ID* field in our routers is subtype 4.

An LLDPDU can only contain one *chassis ID* TLV.

- **Port ID:** Mandatory TLV identifying the port where the LLDPDU is sent. As with *chassis ID*, there are various ways in which a port can be identified. To acknowledge these, there is a subtype field that identifies the type of information contained in the *port ID* field.

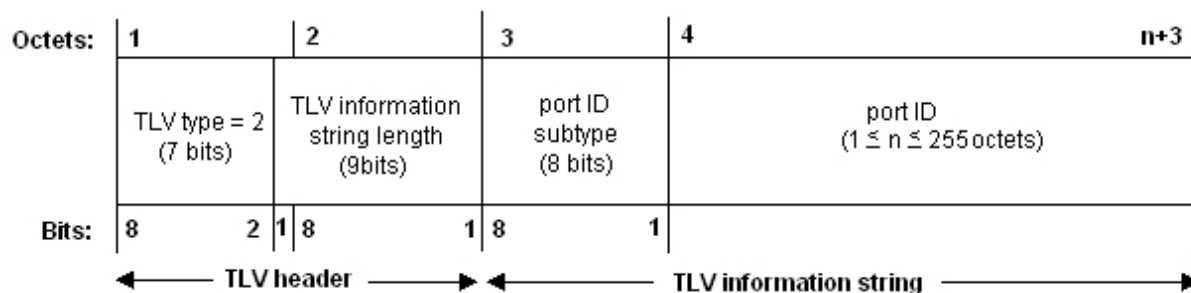

Fig. 5: TLV Port ID Format

Different *port ID* subtypes are shown in the following table:

ID subtype	ID basis
0	Reserved.
1	Interface alias (IETF RFC 2863).
2	Port component (IETF RFC 4133).
3	MAC address (IEEE Std 802).
4	Network address.

5	Interface name (IETF RFC 2863).
6	Agent circuit ID (IETF RFC 2863).
7	Locally assigned.
8-255	Reserved.

Port ID Subtypes

The subtype sent in the router LLDPDUs is number 5, *interface name*, whenever the interface name displayed is the one the packet has been transmitted through.

An LLDPDU can contain a single TLV *Port ID*.

- **TTL:** Mandatory TLV indicating the number of seconds the information is valid for. This TLV takes the following format:

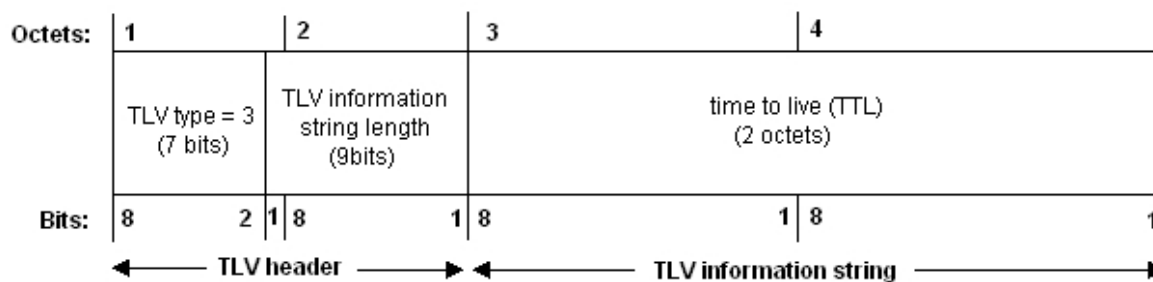

Fig. 6: TLV time to live (TTL)

This has a fixed size given that a valid time to live time is limited in size. This is a value from 0 to 65535 seconds and is calculated with the delay time between frames.

- **End of LLDPDU:** Mandatory TLV indicating the end of the TLVs sequence in an LLDPDU. The format is as follows:

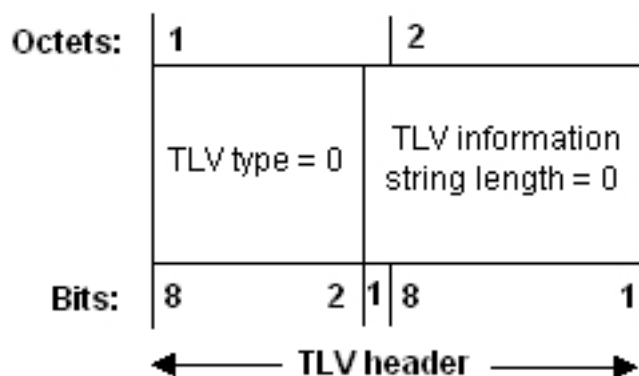

Fig. 7: TLV End of LLDPDU

In addition to basic TLVs, some of them have not been named: there are many more TLVs, which provide different information. These are known as *Organizationally Specific TLVs*. This category allows different organizations (IEEE 802.1, IEEE 802.3 or IETF) to define their own TLVs, which advertise information to remote devices.

Format for the Organizationally Specific TLVs is as follows:

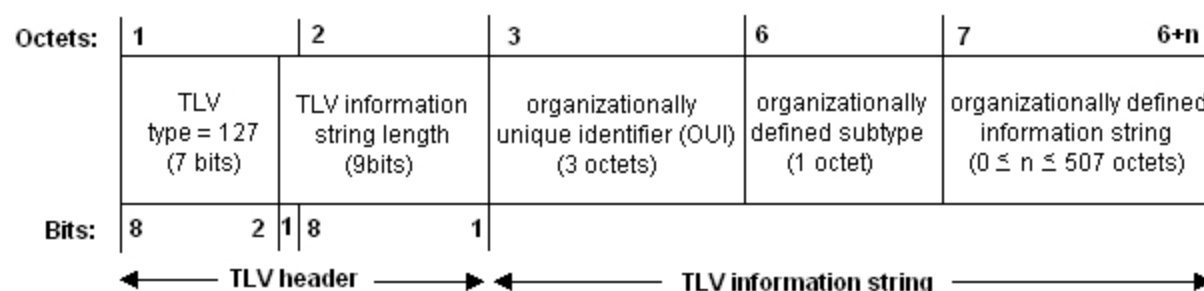

Fig. 8: Organizationally Specific TLV: Basic format

The meaning of each of the fields is as follows:

- *TLV type*: 127 set value for organizationally specific TLVs.
- *TLV information string length*: Information field length in octets.
- *Organizationally unique identifier (OUI)*: Unique organization identifier.
- *Organizationally defined subtype*: Unique subtype assigned by the organization.
- *Organizationally defined information string*: Information advertised in the TLV.

Since the aim is to configure IP telephones in a given VLAN, only two TLVs from the TIA (Telecommunications Industry Association) are sent: LLDP-MED Capabilities and LLDP-MED Network Policy. LLDP-MED (*LLDP-Media Endpoint Discovery*) is an extension of the LLDP protocol, which allows:

- Policy autodiscovery in the LAN (such as VLAN, *Layer 2 priority* or *Differentiated services*).
- To locate the device to create location databases, VoIP.
- *Power over Ethernet*.
- *Inventory management*, which grants a network administrator the power to determine the characteristics of the device.

These TLVs have TIA OUI (00-12-BB), assigned by the IEEE, in common. The subtype is the type of advertised TLV. There are 11 types (ANSI/TIA-1057); the first two, mandatory, are used (this obligation being dependent on the type of device sending it) and contain relevant information on the VLAN.

- **LLDP-MED Capabilities**: allow you to identify LLDP-MED capabilities supported by devices. The format for this TLV is as follows:

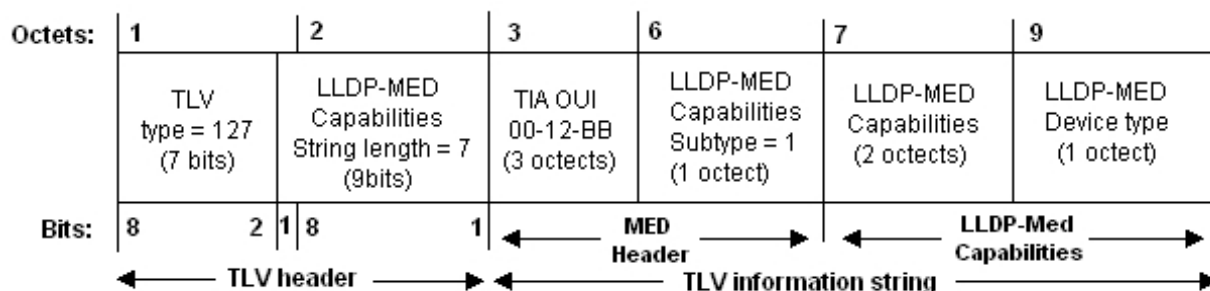

Fig. 9: TLV LLDP-MED Capabilities

The subtype indicates the TLV type (in this case, LLDP-MED *Capabilities*). The LLDP-MED *capabilities* field indicates the type of capabilities supported by the outgoing port, which, in turn, corresponds to the different types of TLVs. The values are shown in the following table:

LLDP-MED capabilities values table

Bit position	Capabilities
0	LLDP-MED Capabilities.
1	Network Policy.
2	Location Identification.
3	Extended Power via MDI-PSE.
4	Extended Power via MDI-PD.
5	Inventory.
6 - 15	Reserved.

The *Device type* field indicates if the device sending the TLV is a network connectivity device or an endpoint. The following table displays the values this field can take, depending on the type of device:

LLDP-MED device types

Value	LLDP-MED Device Type
0	Type not defined.
1	Endpoint Class I.
2	Endpoint Class II.
3	Endpoint Class III.
4	Network Connectivity.
5 - 255	Reserved.

Only one TLV LLDP-MED *Capabilities* value can exist, and this should be the first LLDP-MED TLV to appear in the LLDPDU.

- **LLDP-MED Network Policy:** TLVs allow any device to advertise VLAN configurations associated to port layer 2 and layer 3 characteristics. This is used for networks that support real time traffic and have specific requirements (such as voice and video interactive services).

It has a fixed length, which helps pinpoint the type of VLAN, its identifier and layer 2 and layer 3 priorities, associated with different types of specific applications. The TLV format is as follows:

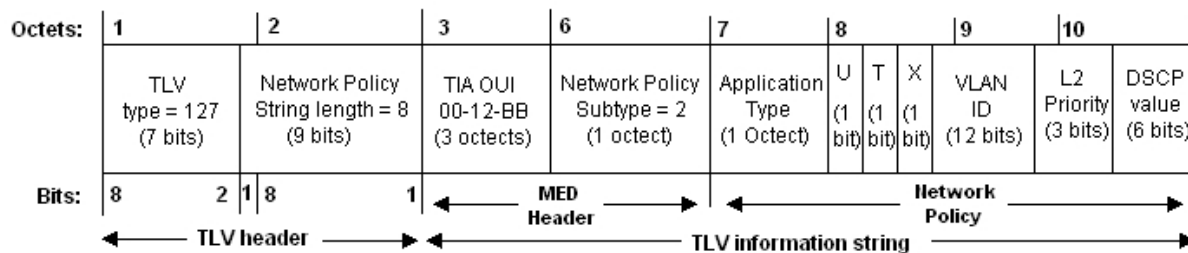

Fig. 10: TLV Network Policy

The *application type* field contains a whole value that identifies the type of application for this TLV (various TLVs can be sent with different types of applications). The following table shows the different applications:

Table containing the application types

Application Type Value	Value Meaning
0	Reserved.
1	Voice.
2	Voice signaling.
3	Guest voice.
4	Guest voice signaling.
5	Softphone voice.
6	Video conferencing.
7	Streaming video.
8	Video signaling.
9 - 25	Reserved.

When it comes to Teldat routers, the application type is voice only (type 1).

U, T and X flags mean the following:

- **U: Unknown Policy flag.** "1" indicates the network policy for this application is unknown. In this case *VLAN ID*, *L2 priority* and *DSCP* fields are ignored. "0" means the network policy is defined.
- **T: Tagged flag.** Shows if the application uses a VLAN with or without a tag. A 0 value indicates the device uses an untagged frame format i.e., *VLAN ID* and *L2 priority* fields are ignored. A 1 value indicates the device uses a tagged frame format (meaning all fields are relevant).
- **X: flag reserved for future use.**

The *VLAN ID* field contains the identifier for the VLAN in question.

Layer 2 priority contains the specific layer 2 priority for the application. This is CoS, *class of service*. Said value can range from 0 to 7.

DSCP contains the value used to provide differentiated services. This value can range from 0 to 63.

On top of the Organizationally Specific TLVs explained before, we can send others using the command explained in section 2.2.3. At the moment, the Organizationally Specific TLVs that can be included through this command are:

- **MAC/PHY Configuration/Status TLV (IEEE 802.3):** This TLV gives information on *Autonegotiation*, *Advertised Capabilities* and *Status* of the interface or the switch port used. The TLV format is as follows:

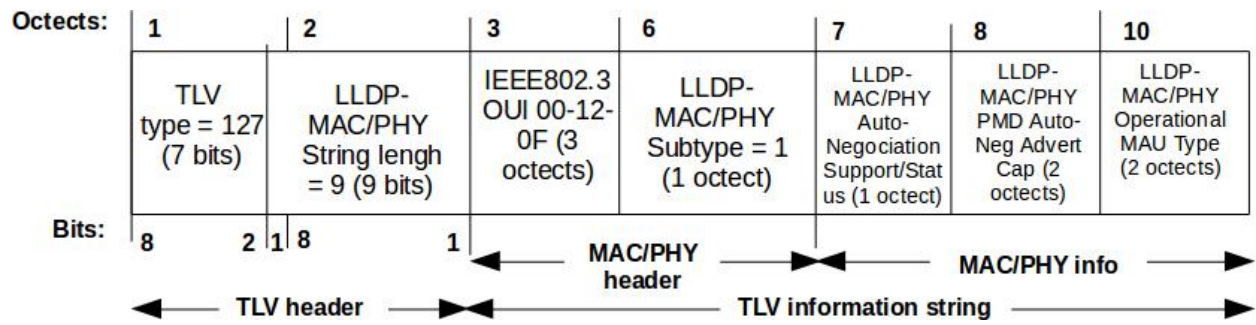

Fig. 11: TLV MAC/PHY Configuration/Status

The *Auto-Negotiation Support/Status* field says if the interface/switch supports Auto-Negotiation feature and, if so, if it is enabled or disabled.

The *PMD Auto-Negotiation Advertised Capability* field shows the interface/switch capabilities (speed, half/full duplex mode, PAUSE, etc).

The *Operational MAU Type* field shows the current operation mode of the interface/switch.

Chapter 2 Configuration

2.1 Accessing the configuration

LLDP configuration is carried out in the Ethernet interfaces and subinterfaces configuration menu. To access an interface configuration menu, run **net** followed by the interface identifier in the global configuration menu.

Example:

```
*config
Config>net ethernet0/0
-- Ethernet Interface User Configuration --
ethernet0/0 config>
```

Example:

```
*config
Config>net ethernet0/0.101
-- Ethernet Subinterface Configuration --
ethernet0/0.101 config>
```

2.2 LLDP Configuration Commands

LLDP configuration is carried out through the **lldp** command in the Ethernet interface or subinterface menu. This section describes the different options associated to this command.



Note

Use **no lldp** to return to the default configuration associated to a previously configured parameter.

2.2.1 LLDP ENABLE

Enables LLDP frame sending in an interface. To disable LLDP frame sending in an interface, use **no lldp enable**.

Syntax:

```
lldp enable
```

Example:

```
ethernetx/x config$lldp enable ?
<cr>
ethernetx/x config$lldp enable
ethernetx/x config$
```

Default value: LLDP is disabled in an interface.

2.2.2 LLDP TIMER

Configures periodic LLDP frame sending for an interface.

Syntax:

```
lldp timer <value_secs>
```

Example:

```
ethernetx/x config$lldp timer ?
<1..3600> Rate at which LLDP packets are sent (in sec)
ethernetx/x config$lldp timer 10 ?
<cr>
ethernetx/x config$lldp timer 10
```

```
ethernetx/x config$
```

Default value: 30 seconds.

2.2.3 LLDP TLV-SELECT

Use this command to add some additional *Organizationally Specific TLV* to the LLDP frame. Remember that, by default, we only send two *Organizationally Specific TLV* (LLDP-MED Capabilities and LLDP-MED Network Policy).

Syntax:

```
lldp tlv-select {mac-phy-cfg}
```

Command history:

Release	Modification
11.01.04	This command was introduced as of version 11.01.04.

2.2.3.1 LLDP TLV-SELECT MAC-PHY-CFG

This command adds the MAC/PHY Configuration/Status TLV (IEEE 802.3) to the LLDP packet. This TLV gives information about *Autonegotiation*, *Advertised Capabilities* and *Status* of the interface or the switch port. To disable MAC/PHY TLV sending, use **no lldp tlv-select mac-phy-cfg**.

Syntax:

```
ethernetx/x config$lldp tlv-select ?
  mac-phy-cfg    MAC/PHY Configuration/Status TLV
ethernetx/x config$lldp tlv-select mac-phy-cfg ?
  <cr>
ethernetx/x config$lldp tlv-select mac-phy-cfg

ethernetx/x config$
```

Default value: LLDP does not send MAC/PHY TLV.

Command history:

Release	Modification
11.01.04	This command was introduced as of version 11.01.04.

2.2.4 LLDP VOICE

Configures voice information sending to an IP telephone.

Syntax:

```
lldp voice vlan {<vlan_id> [cos <cos_val> | dscp <dscp_val>] | untagged}
```

2.2.4.1 LLDP VOICE VLAN UNTAGGED

This tells the IP telephone to send untagged VLAN voice traffic.

Example:

```
ethernet0/0 config$lldp voice vlan ?
  untagged    Untagged voice traffic
  <1..4094>   Specify the native VLAN for voice traffic
ethernet0/0 config$lldp voice vlan untagged

ethernet0/0 config$
```

2.2.4.2 LLDP VOICE VLAN <vlan id>

This tells the IP telephone to tag voice traffic in the configured VLAN.

Example:

This tells the IP telephone to tag voice traffic in VLAN 101.

```

ethernet0/0 config$lldp voice vlan ?
  untagged      Untagged voice traffic
  <1..4094>     Specify the native VLAN for voice traffic
ethernet0/0 config$lldp voice vlan 101 ?
  cos          Specify the L2 priority class of service for the configured VLAN
  dscp         Specify the diff-serv code point value for the configured VLAN
  <cr>
ethernet0/0 config$lldp voice vlan 101

ethernet0/0 config$

```

Default value: LLDP does not send voice information.

2.2.4.3 LLDP VOICE VLAN <vlan id> COS <cos val>

Indicates the type of layer 2 priority (*Class of Service*, CoS), which must be configured.

Example:

This indicates service class 3 is configured:

```

ethernet0/0 config$lldp voice vlan 101 cos ?
  <0..7>       Specify the L2 priority class of service
ethernet0/0 config$lldp voice vlan 101 cos 3
ethernet0/0 config$

```

Default value: LLDP sends a CoS 5.

2.2.4.4 LLDP VOICE VLAN <vlan id> DSCP <dscp val>

Indicates the DSCP (*Differentiated Service Code Point*) value to be configured.

Example:

Indicates a DSCP 15 is configured:

```

ethernet0/0 config$lldp voice vlan 101 dscp ?
  <0..63>     Specify the diff-serv code point value
ethernet0/0 config$lldp voice vlan 101 dscp 15
ethernet0/0 config$

```

Default value: LLDP sends a DSCP 46.

Chapter 3 Configuration Example

3.1 Configuring LLDP

In the following scenario, we want the router to send LLDP traffic every 10 seconds. We also want to configure the IP telephone so it uses VLAN 8.

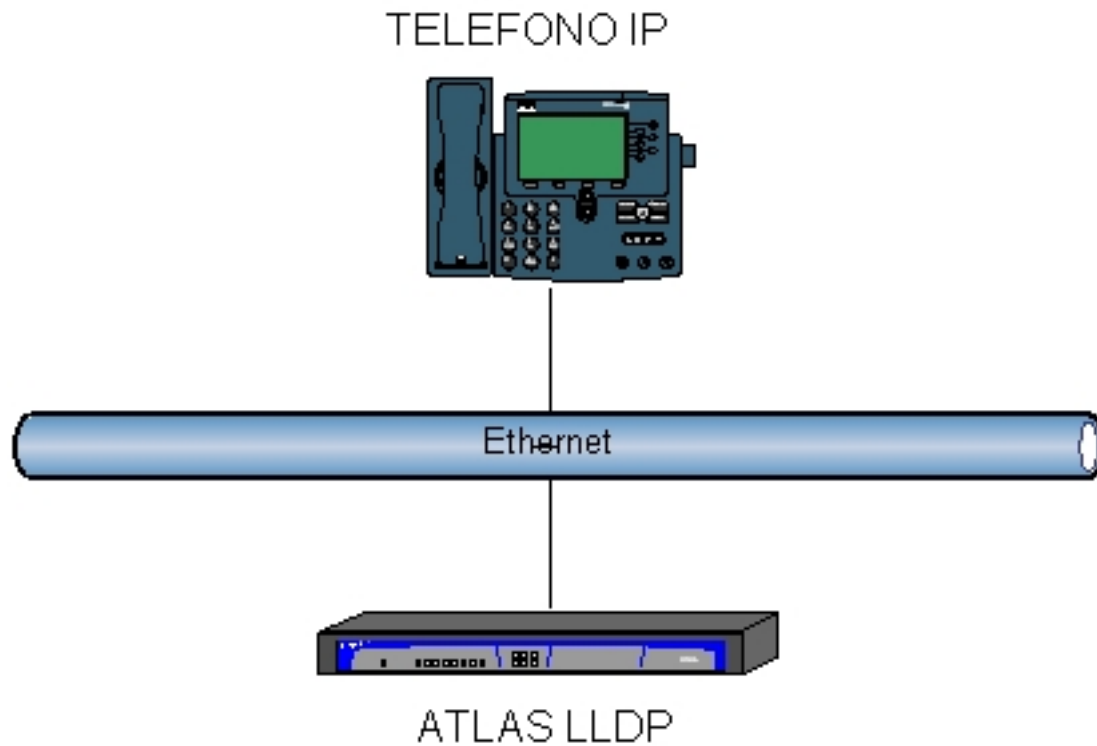

Fig. 12: LLDP configuration is as follows:

```
lldp enable
lldp timer 10
lldp voice vlan 8
lldp voice vlan untagged
```